

CSE 250

Data Structures

Dr. Eric Mikida
epmikida@buffalo.edu

Dr. Oliver Kennedy
okennedy@buffalo.edu

212 Capen Hall

Day 10
Linked Lists and Iterators
Textbook Ch. 7

Announcements

- Starting next week, my Tuesday offices hours are moving to Thursday

Recap of Amortized Runtime

- Let's say we want to insert n elements into an **ArrayBuffer** that has an initial size of x ...
- Some insertions will be very cheap ($\Theta(1)$) because we don't have to resize the underlying **Array**
- Some insertions will be expensive, because before we insert, we will have to create a copy of the underlying **Array**
- If we double the size each time, then an expensive insert that costs $\Theta(2^j x)$ also buys us the luxury of the next $(2^j - 1)x$ insertions being cheap (only costing $\Theta(1)$).

Summary of Seq So Far

`Array[T]`

Pros: $O(1)$ apply, update

Cons: $O(n)$ remove, insert, append

`ArrayBuffer[T]`

Pros: $O(1)$ apply, update, Amortized $O(1)$ append

Cons: $O(n)$ insert, remove

`List[T]` (linked list)

Pros: ???

Cons: ???

Linked Lists

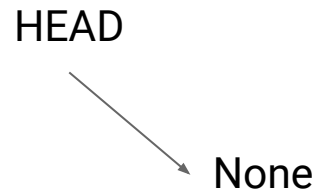

Linked Lists

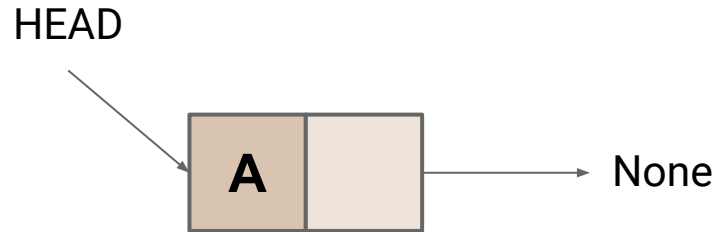

Linked Lists

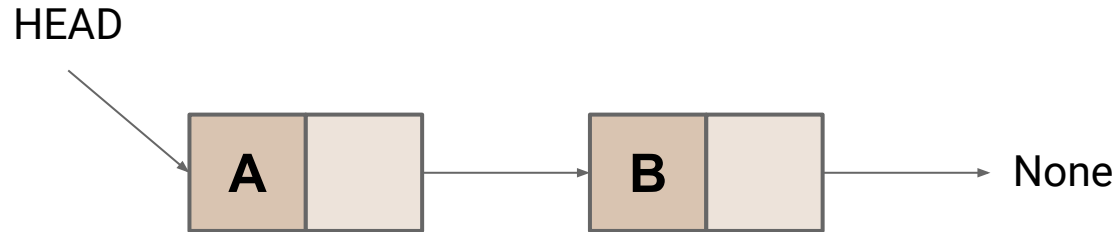

Linked Lists

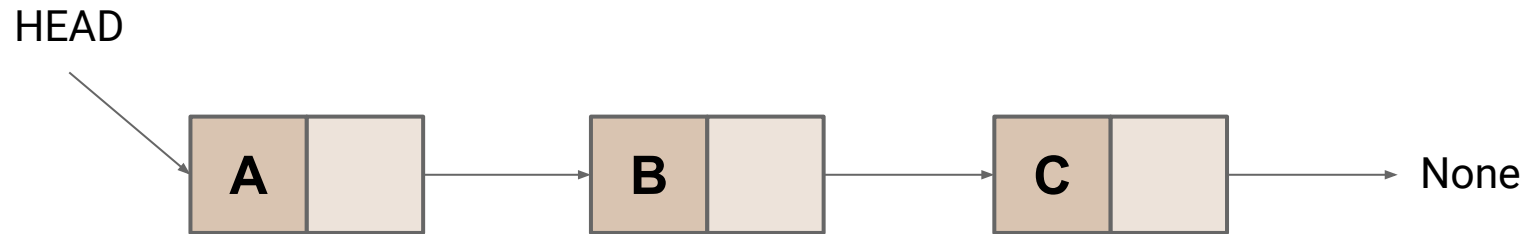

Linked Lists

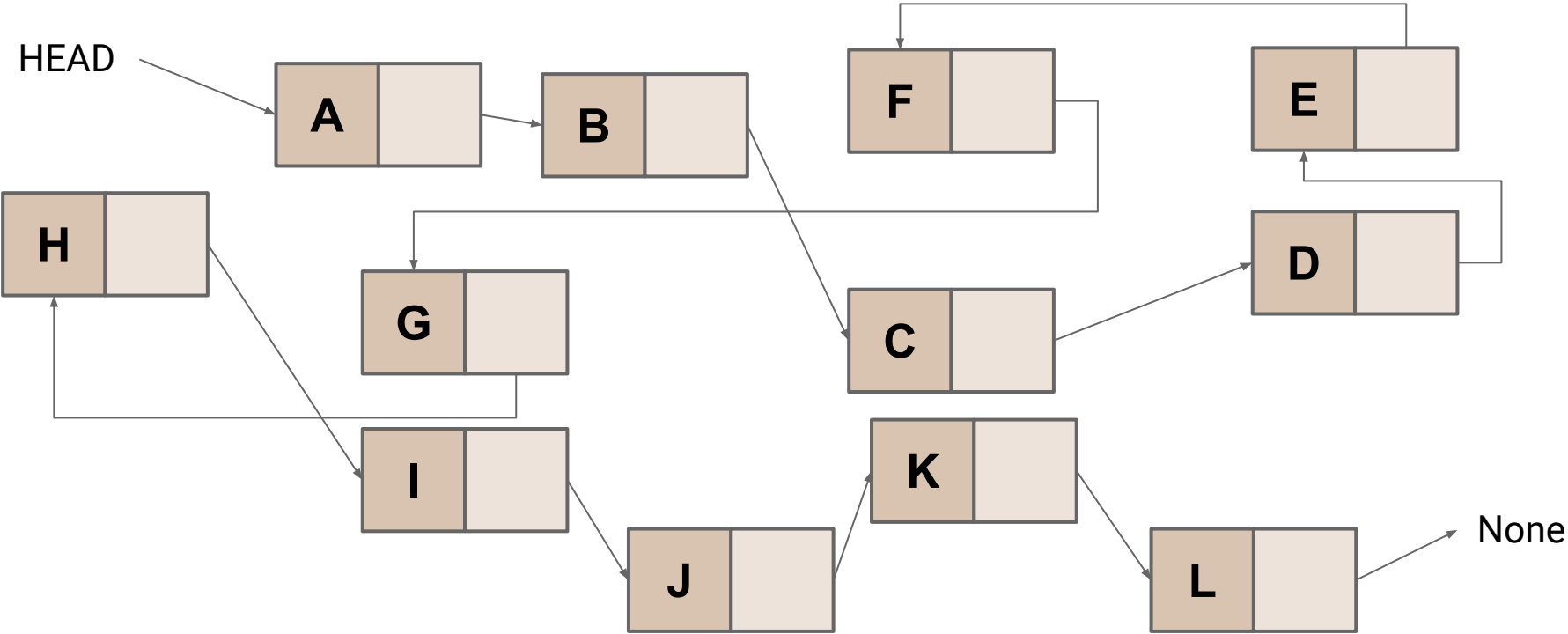

mutable.List[T] : mutable.Seq[T]

```
class SinglyLinkedList[T] extends Seq[T] {  
  var head: Option[SinglyLinkedListNode[T]] = None  
  /* ... */  
}
```

```
class SinglyLinkedListNode(  
  var value: T,  
  var next: Option[SinglyLinkedListNode[T]] = None  
)
```

mutable.List[T] : mutable.Seq[T]

```
class SinglyLinkedList[T] extends Seq[T] {  
  var head: Option[SinglyLinkedListNode[T]] = None  
  /* ... */  
}
```

Class for our list, which right now just has a reference to `head` (an `Option`)

```
class SinglyLinkedListNode (  
  var value: T,  
  var next: Option[SinglyLinkedListNode[T]] = None  
)
```

mutable.List[T] : mutable.Seq[T]

```
class SinglyLinkedList[T] extends Seq[T] {  
    var head: Option[SinglyLinkedListNode[T]] = None  
    /* ... */  
}
```

Class for our list, which right now just has a reference to **head** (an **Option**)

Class for a node in the list, which has a **value**, and a reference to the **next** node (an **Option**)

```
class SinglyLinkedListNode (  
    var value: T,  
    var next: Option[SinglyLinkedListNode[T]] = None  
)
```

The mutable.Seq ADT

`apply(idx: Int): [A]`

Get the element (of type **A**) at position `idx`

`iterator: Iterator[A]`

Get access to view all elements in the sequence, in order, once

`length: Int`

Count the number of elements in the seq

`insert(idx: Int, elem: A): Unit`

Insert an element at position `idx` with value `elem`

`remove(idx: Int): A`

Remove the element at position `idx`, and return the removed value

Implementing length

```
def length: Int = {  
  var i = 0  
  var curr = head  
  while(curr.isDefined){ i += 1; curr = curr.get.next }  
  return i  
}
```

Implementing length

```
def length: Int = {  
  var i = 0  
  var curr = head  
  while(curr.isDefined){ i += 1; curr = curr.get.next }  
  return i  
}
```

Complexity: $O(n)$

Implementing length

Idea: Keep track of the length

```
class SinglyLinkedList[T] extends Seq[T] {  
  var head: Option[SinglyLinkedListNode[T]] = None  
  var length = 0  
  /* ... */  
}
```

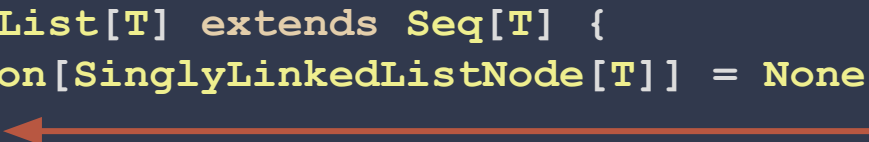

Complexity: $O(1)$

Implementing apply

`apply(2)`

HEAD

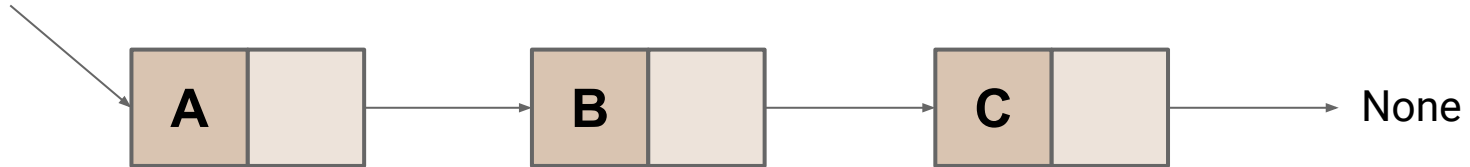

Implementing apply

`apply(2)`

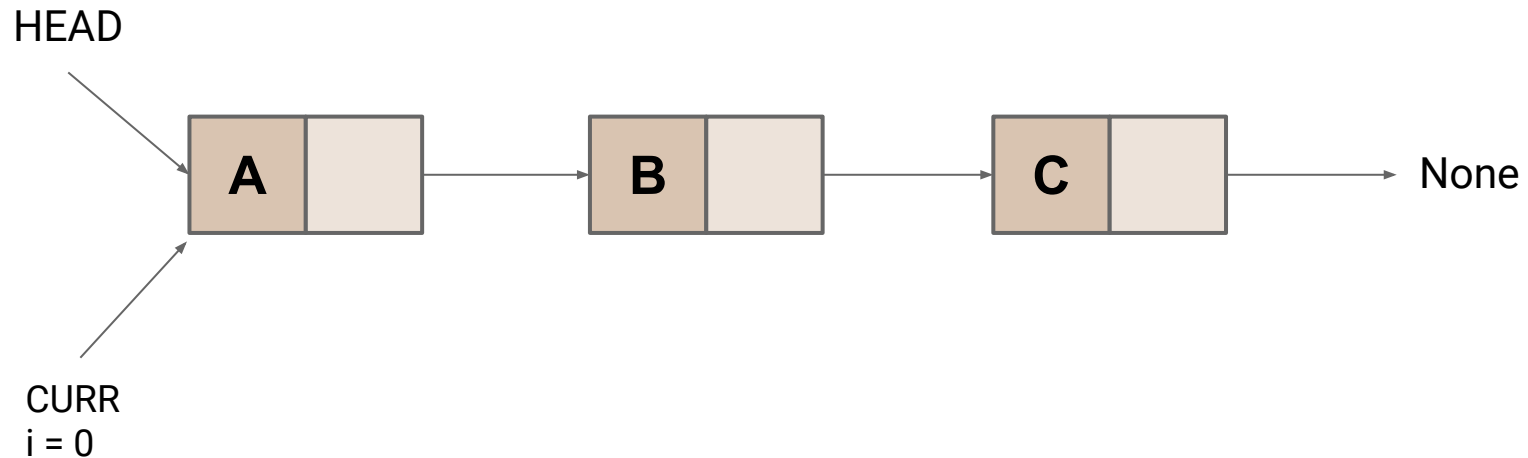

Implementing apply

`apply (2)`

HEAD

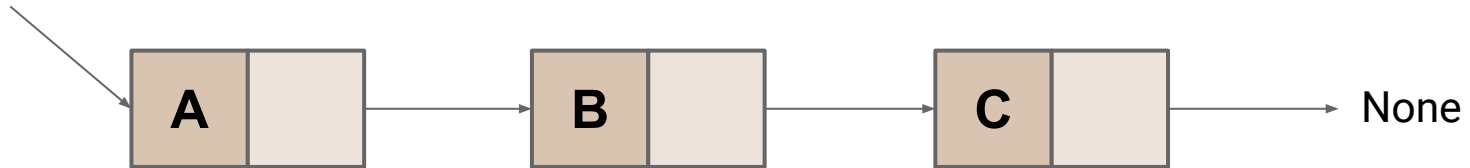

CURR
i = 1

Implementing apply

`apply (2)`

HEAD

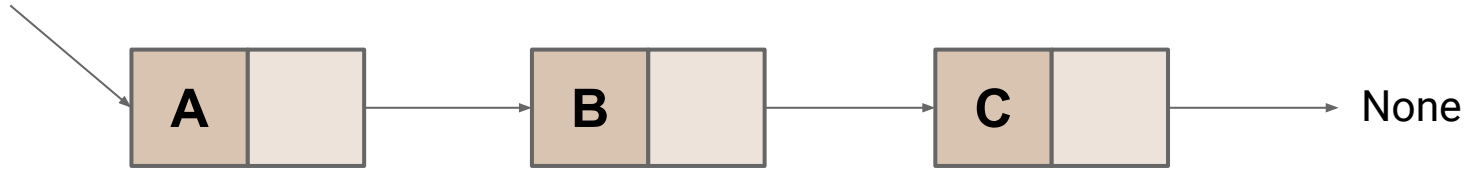

CURR
i = 2

Implementing apply

```
def apply(idx: Int): T = {  
  var i = 0  
  var curr = head  
  while(i < idx){  
    if(curr.isEmpty) { throw IndexOutOfBoundsException(idx) }  
    i += 1; curr = curr.get.next  
  }  
  if(curr.isEmpty) { throw IndexOutOfBoundsException(idx) }  
  return curr  
}
```

Implementing apply

```
def apply(idx: Int): T = {  
  var i = 0  
  var curr = head  
  while(i < idx){  
    if(curr.isEmpty) { throw IndexOutOfBoundsException(idx) }  
    i += 1; curr = curr.get.next  
  }  
  if(curr.isEmpty) { throw IndexOutOfBoundsException(idx) }  
  return curr  
}
```

Iterate
until we
reach idx

Implementing apply

```
def apply(idx: Int): T = {  
  var i = 0  
  var curr = head  
  while(i < idx){  
    if(curr.isEmpty) { throw IndexOutOfBoundsException(idx) }  
    i += 1; curr = curr.get.next  
  }  
  if(curr.isEmpty) { throw IndexOutOfBoundsException(idx) }  
  return curr  
}
```

Iterate until we reach idx

Complexity: $O(n)$ (or $\Theta(\text{idx})$)

Implementing `insert`

`insert(1, "D")`

HEAD

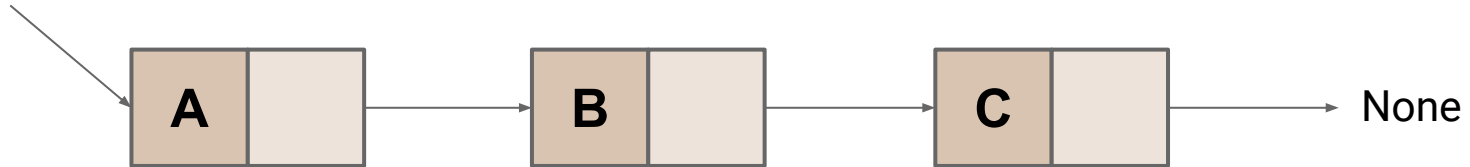

Implementing insert

`insert(1, "D")`

HEAD



None

CURR
i = 0



Implementing insert

`insert(1, "D")`

HEAD

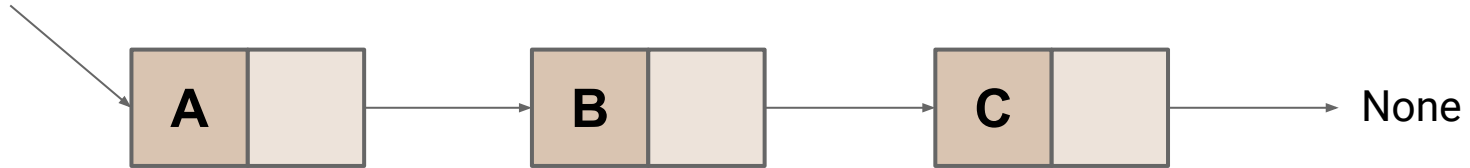

CURR
i = 1

Implementing insert

`insert(1, "D")`

HEAD

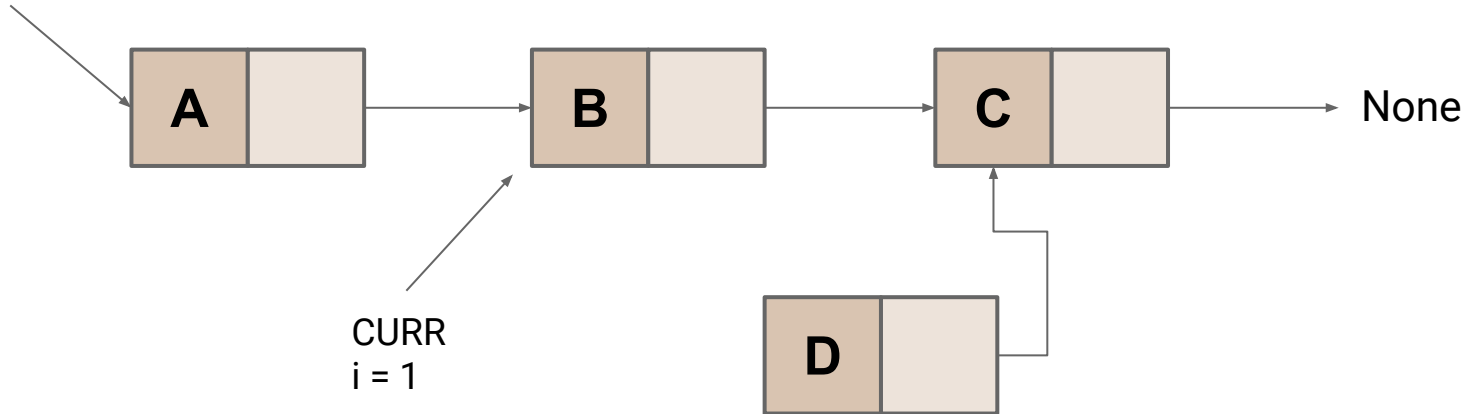

Implementing insert

`insert(1, "D")`

HEAD

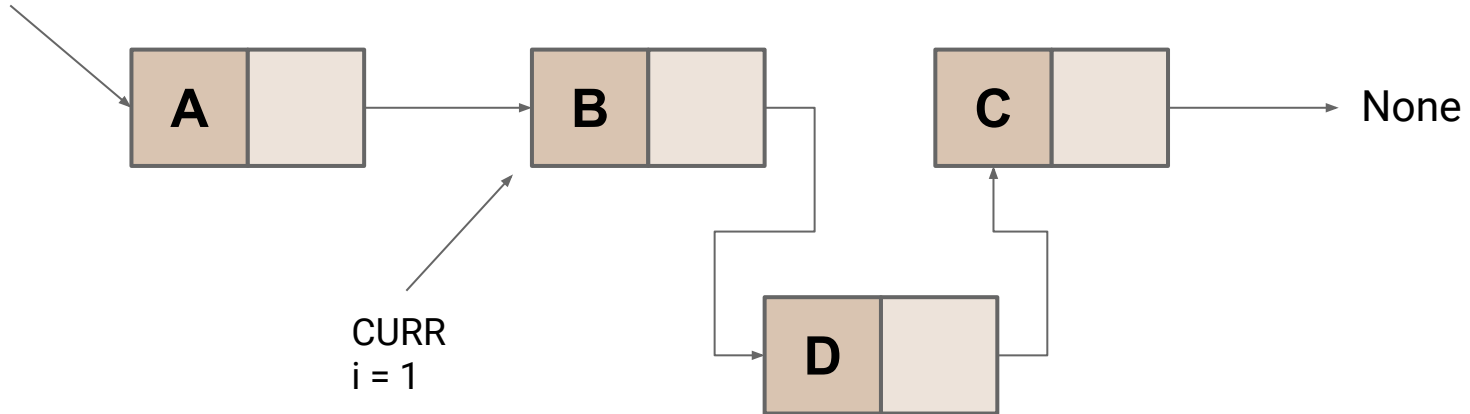

Implementing insert

```
def insert(idx: Int, value: T): Unit = {
  if(idx == 0) {
    head = Some( new SinglyLinkedListNode(value, head) )
  } else {
    var i = 1; var curr = head
    while(i < idx) {
      if(curr.isEmpty) { throw IndexOutOfBoundsException(idx) }
      i += 1; curr = curr.get.next
    }
    curr.next = Some(new SinglyLinkedListNode(value, curr.next))
  }
  length += 1
}
```

Implementing insert

```
def insert(idx: Int, value: T): Unit = {
  if(idx == 0) {
    head = Some( new SinglyLinkedListNode(value, head) )
  } else {
    var i = 1; var curr = head
    Iterate until we reach idx {
      while(i < idx) {
        if(curr.isEmpty) { throw IndexOutOfBoundsException(idx) }
        i += 1; curr = curr.get.next
      }
      curr.next = Some(new SinglyLinkedListNode(value, curr.next))
    }
    length += 1
  }
}
```

Implementing insert

```
def insert(idx: Int, value: T): Unit = {
  if(idx == 0) {
    head = Some( new SinglyLinkedListNode(value, head) )
  } else {
    var i = 1; var curr = head
    Iterate until we reach idx {
      while(i < idx) {
        if(curr.isEmpty) { throw IndexOutOfBoundsException(idx) }
        i += 1; curr = curr.get.next
      }
      curr.next = Some(new SinglyLinkedListNode(value, curr.next))
    }
    length += 1
  }
}
```

Create a new node pointing to curr.next and update curr.next

Implementing insert

```
def insert(idx: Int, value: T): Unit = {
  if(idx == 0) {
    head = Some( new SinglyLinkedListNode(value, head) )
  } else {
    var i = 1; var curr = head
    while(i < idx) {
      if(curr.isEmpty) { throw IndexOutOfBoundsException(idx) }
      i += 1; curr = curr.get.next
    }
    curr.next = Some(new SinglyLinkedListNode(value, curr.next))
  }
  length += 1
}
```

Iterate until we reach idx

Create a new node pointing to curr.next and update curr.next

Complexity: $O(n)$ (or $\Theta(\text{idx})$)

**Let's try actually using
apply...**

Using apply

```
def sum(list: List[Int]): Unit = {  
  val total: Int = 0  
  for(i <- 0 until list.size){ total += list(i) }  
  return total  
}
```

What is the complexity?

Using apply

```
def sum(list: List[Int]): Unit = {  
  val total: Int = 0  
  for(i <- 0 until list.size){ total += list(i) }  
  return total  
}
```

Iterate over the whole
list: $O(n)$

What is the complexity?

Using apply

```
def sum(list: List[Int]): Unit = {  
  val total: Int = 0  
  for(i <- 0 until list.size){ total += list(i) }  
  return total  
}
```

Iterate over the whole
list: $O(n)$

What is the complexity?

Call apply: $O(n)$

Using `apply`

$$\sum_{i=0}^{n-1} T_{\text{apply}}(i) = \sum_{i=0}^{n-1} i$$

Using apply

$$\sum_{i=0}^{n-1} T_{\text{apply}}(i) = \sum_{i=0}^{n-1} i$$

$$= \sum_{i=0}^{n-1} \frac{(n-1)(n-1+1)}{2} = \frac{n^2 - n}{2} = \Theta(n^2)$$

Using apply

$$\sum_{i=0}^{n-1} T_{\text{apply}}(i) = \sum_{i=0}^{n-1} i$$

$$= \sum_{i=0}^{n-1} \frac{(n-1)(n-1+1)}{2} = \frac{n^2 - n}{2} = \Theta(n^2)$$

Can we do better?

A Different Approach...

```
def sum(list: List[Int]): Unit = {  
  val total: Int = 0  
  val curr = list.head  
  while(curr.isDefined){  
    total += curr.get.value  
    curr = curr.get.next  
  }  
  return total  
}
```

A Different Approach...

```
def sum(list: List[Int]): Unit = {  
  val total: Int = 0  
  val curr = list.head           Start at the head  
  while(curr.isDefined){  
    total += curr.get.value  
    curr = curr.get.next  
  }  
  return total  
}
```

A Different Approach...

```
def sum(list: List[Int]): Unit = {  
  val total: Int = 0  
  val curr = list.head  
  while (curr.isDefined) {  
    total += curr.get.value  
    curr = curr.get.next  
  }  
  return total  
}
```

Start at the head

Go as long as there are nodes

A Different Approach...

```
def sum(list: List[Int]): Unit = {  
  val total: Int = 0  
  val curr = list.head  
  while (curr.isDefined) {  
    total += curr.get.value  
    curr = curr.get.next  
  }  
  return total  
}
```

Start at the head

Go as long as there are nodes

Add to the total

A Different Approach...

```
def sum(list: List[Int]): Unit = {  
  val total: Int = 0  
  val curr = list.head  
  while (curr.isDefined) {  
    total += curr.get.value  
    curr = curr.get.next  
  }  
  return total  
}
```

Start at the head

Go as long as there are nodes

Add to the total

Go to the next item

A Different Approach...

```
def sum(list: List[Int]): Unit = {  
  val total: Int = 0  
  val curr = list.head           Start at the head  
  while (curr.isDefined) {      Go as long as there are nodes  
    total += curr.get.value     Add to the total  
    curr = curr.get.next       Go to the next item  
  }  
  return total  
}
```

Now what is our complexity?

A Different Approach...

```
def sum(list: List[Int]): Unit = {  
  val total: Int = 0  
  val curr = list.head           Start at the head  
  while (curr.isDefined) {      Go as long as there are nodes  
    total += curr.get.value      Add to the total  
    curr = curr.get.next        Go to the next item  
  }  
  return total  
}
```

Now what is our complexity?

$$\sum_{i=0}^{n-1} \Theta(1) = (n - 1 + 1) \cdot \Theta(1) = \Theta(n)$$

Access-by-Reference vs -by-Index

Why does this work?

What is the expensive part of `apply`?

Access-by-Reference vs -by-Index

Index \rightarrow Value: $\Theta(idx)$
(access by index)

`SinglyLinkedListNode` \rightarrow Value: $\Theta(1)$
(access by reference)

Iterator [T]

hasNext: Boolean

Returns `true` if there are more items to retrieve

next: T

Returns the next item to retrieve

Iterator [T]

hasNext: Boolean

Returns `true` if there are more items to retrieve

next: T

Returns the next item to retrieve

*An iterator is a **reference** to an element of a collection*

ListIterator[T] : Iterator[T]

```
class ListIterator[T] (  
  var curr: Option[SinglyLinkedListNode[T]]) {  
  def hasNext: Boolean = curr.isDefined  
  def next: T = {  
    val ret = curr.get.value  
    curr = curr.get.next  
    return ret  
  }  
}
```

List: Positional Operations

What if we try something like:

```
insertAfter(pos: SinglyLinkedListNode[T], value: T)
```

Implementing insertAfter

`insertAfter(pos, "D")`

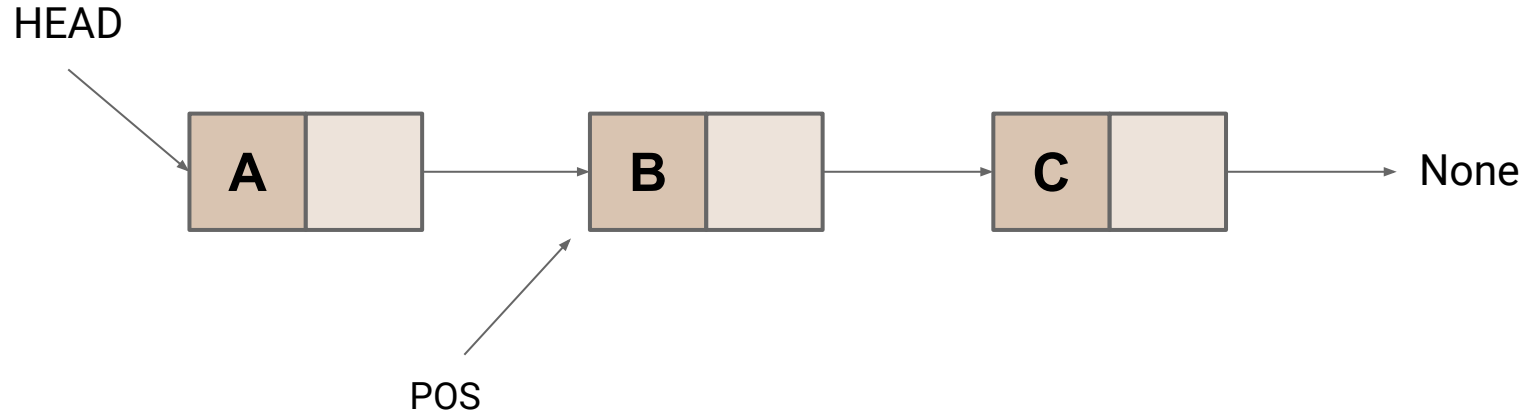

Implementing insertAfter

`insertAfter(pos, "D")`

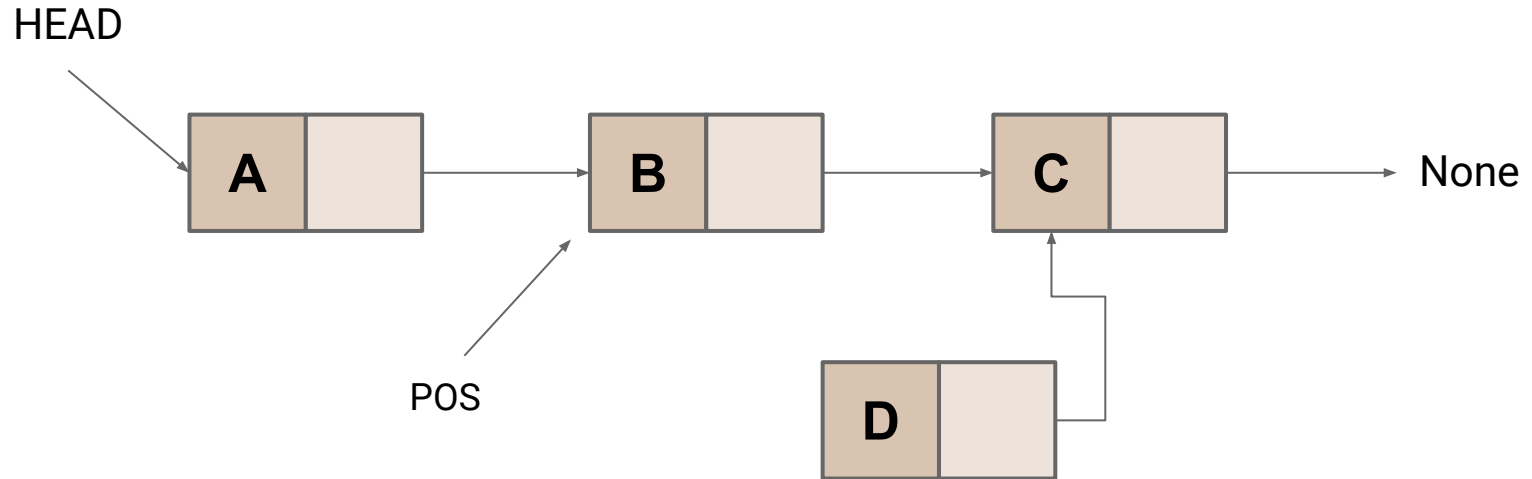

Implementing insertAfter

`insertAfter(pos, "D")`

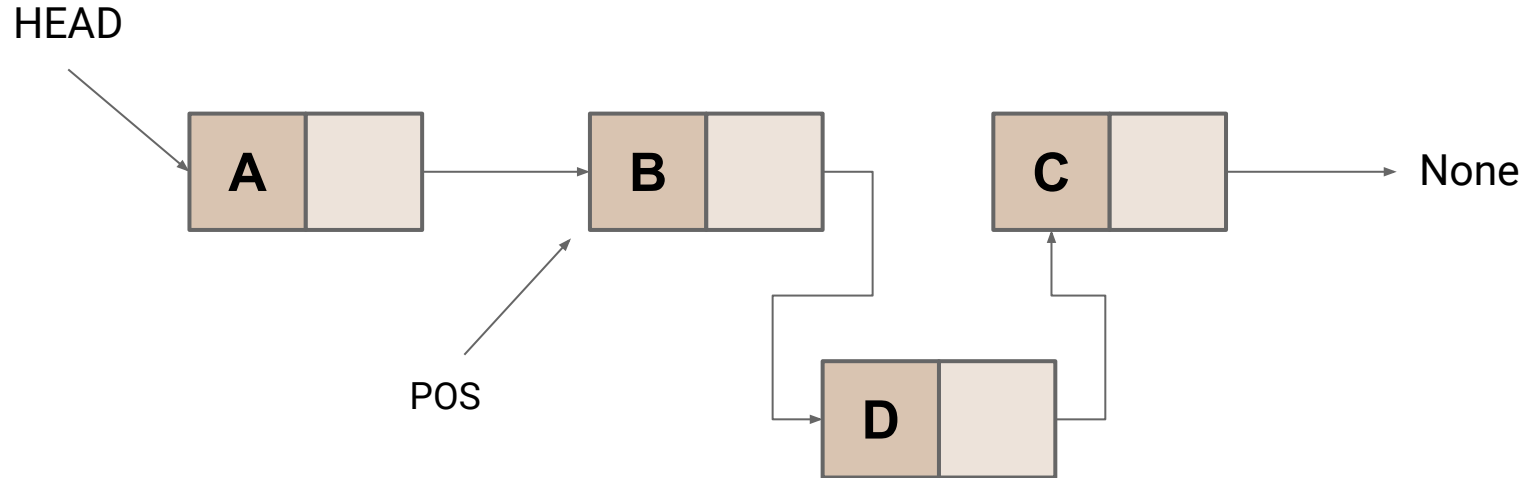

Implementing insertAfter

```
def insertAfter(pos: SinglyLinkedListNode[T], value: T) = {  
  pos.next = Some(  
    new SinglyLinkedListNode(value, pos.next)  
  )  
  length += 1  
}
```

Implementing insertAfter

```
def insertAfter(pos: SinglyLinkedListNode[T], value: T) = {  
  pos.next = Some(  
    new SinglyLinkedListNode(value, pos.next)  
  )  
  length += 1  
}
```

Complexity: $\Theta(1)$

Implementing positional `remove`

How would you implement a positional `remove`?

Implementing Positional remove

`remove(pos)`

HEAD

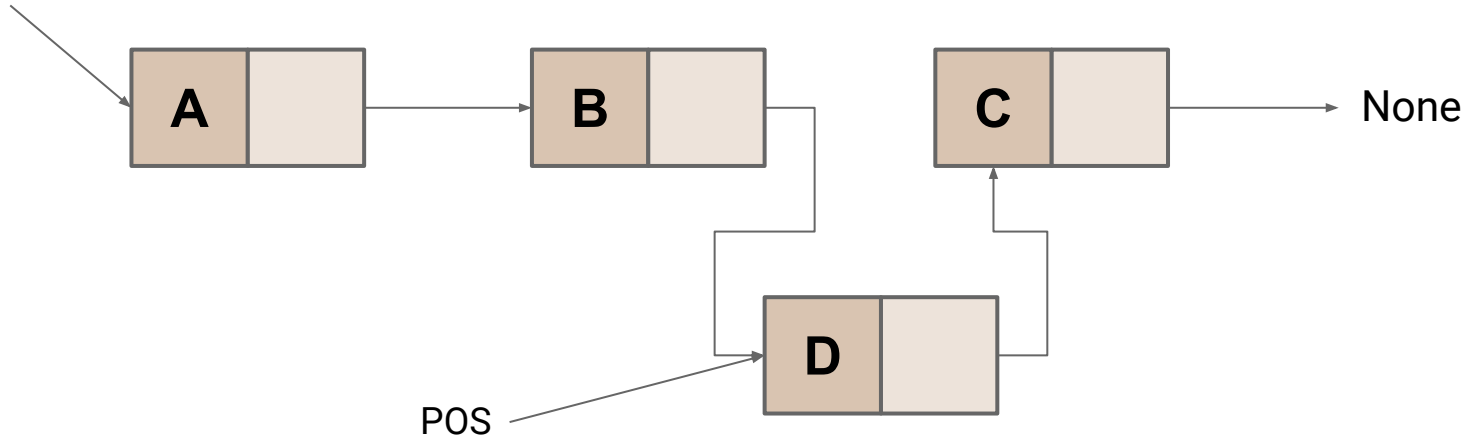

Implementing positional `remove`

How would you implement a positional `remove`?

```
def remove(pos: SinglyLinkedListNode[T]): T = {  
  val prev = ???  
  prev.next = pos.next  
  length -= 1  
  return pos.get.value  
}
```

Implementing positional `remove`

How would you implement a positional `remove`?

```
def remove(pos: SinglyLinkedListNode[T]): T = {  
  val prev = ???           Problem: ...how do we find the previous node?  
  prev.next = pos.next  
  length -= 1  
  return pos.get.value  
}
```

Implementing positional `remove`

Idea: Use a "backward" pointer.

DoublyLinkedList

```
class DoublyLinkedList[T] extends Seq[T] {  
  var head: Option[DoublyLinkedListNode[T]] = None  
  var last: Option[DoublyLinkedListNode[T]] = None  
  var length = 0  
  
  /* ... */  
}
```

```
class DoublyLinkedListNode[T] (  
  var value: T,  
  var next: Option[DoublyLinkedListNode[T]] = None  
  var prev: Option[DoublyLinkedListNode[T]] = None  
)
```

Re-implementing positional `insertAfter`

```
def insertAfter(pos: DoublyLinkedListNode[T], value: T) = {  
  val newNode  
    = new DoublyLinkedListNode(value, prev = Some(pos))  
  if(pos.next.isDefined) {  
    pos.next.prev = Some(newNode)  
    newNode.next = pos.next  
  } else {  
    last = newNode  
    newNode.next = None  
  }  
  pos.next = Some(newNode)  
  length += 1  
}
```

Re-implementing positional `insertAfter`

```
def insertAfter(pos: DoublyLinkedListNode[T], value: T) = {  
  val newNode  
    = new DoublyLinkedListNode(value, prev = Some(pos))  
  if(pos.next.isDefined) {  
    pos.next.prev = Some(newNode)  
    newNode.next = pos.next  
  } else {  
    last = newNode  
    newNode.next = None  
  }  
  pos.next = Some(newNode)  
  length += 1  
}
```



*prev of the new node
is the position we are
inserting after*

Re-implementing positional `insertAfter`

```
def insertAfter(pos: DoublyLinkedListNode[T], value: T) = {  
  val newNode  
    = new DoublyLinkedListNode(value, prev = Some(pos))  
  if(pos.next.isDefined) {  
    pos.next.prev = Some(newNode)  
    newNode.next = pos.next  
  } else {  
    last = newNode  
    newNode.next = None  
  }  
  pos.next = Some(newNode)  
  length += 1  
}
```

Insert differs
depending on
whether the
new node is
now the end
or not

*prev of the new node
is the position we are
inserting after*



Implementing positional remove

```
def remove(pos: DoublyLinkedListNode[T]): T = {  
  if (pos.prev.isDefined) { pos.prev.next = pos.next }  
  else                       { head = pos.next }  
  
  if (pos.next.isDefined) { pos.next.prev = pos.prev }  
  else                       { tail = pos.prev }  
  
  length -= 1  
  return pos.get.value  
}
```

Seq Summary So Far

Operation	Array [T]	ArrayBuffer [T]	List [T] (index)	List [T] (ref)
<code>apply (i)</code>	$\Theta(1)$	$\Theta(1)$	$\Theta(i), O(n)$	$\Theta(1)$
<code>update (i, val)</code>	$\Theta(1)$	$\Theta(1)$	$\Theta(i), O(n)$	$\Theta(1)$
<code>insert (i, val)</code>	$\Theta(n)$	$O(n)$	$\Theta(i), O(n)$	$\Theta(1)$
<code>remove (i, val)</code>	$\Theta(n)$	$\Theta(n-i), O(n)$	$\Theta(i), O(n)$	$\Theta(1)$
<code>append (i)</code>	$\Theta(n)$	$O(n), \text{Amortized } \Theta(1)$	$\Theta(i), O(n)$	$\Theta(1)$